

Advanced Handheld Tachometer

# FT-7200

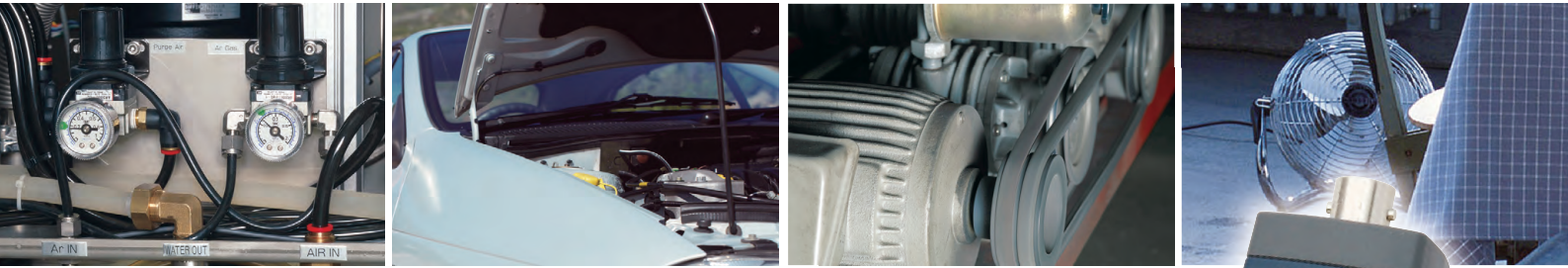

Measure engine rotation speed via cigarette lighter socket sensor!



Cigarette lighter socket sensor  
FT-0801



# ONOSOKKI

# FT-7200 Advanced Handheld Tachometer

Rotation pulse not needed. Rotation speed measured via light, magnetism, vibration, sound, etc.

*Rotation speed measured via sound and vibration!*

*Measures engine rotation speed via cigarette lighter socket sensor!*



## Overview

The FT-7200 is a handheld tachometer that measures rotation speed by performing frequency analysis using FFT calculations. It can perform non-contact measurement using sound, vibration, and others, without modifying the rotating shaft.

## Features

- Differences from a previous model
  - A new measurement mode has been added, making measurements possible that were before infeasible.
  - Improved following up performance of acceleration and deceleration.
  - Pulse output function available in addition to analog output function.
- Effective for measuring engine rotation of cars, etc.
- A wide range of sensors can be used, including cigarette lighter socket sensor.
- Provided with averaging function and filtering function

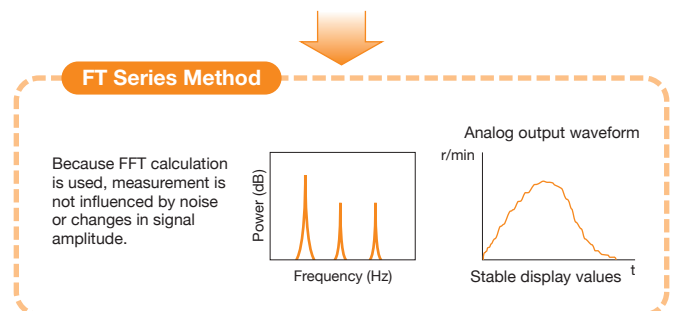
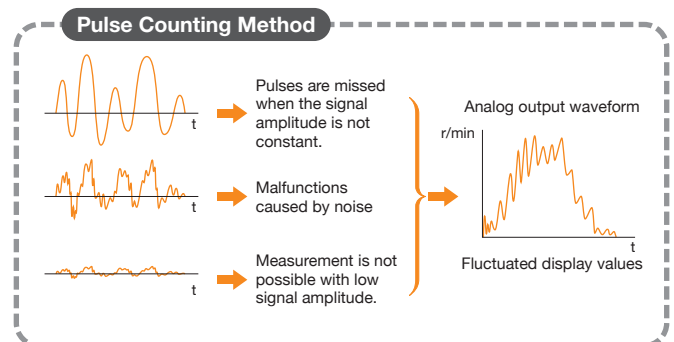



## Algorithms

Five different algorithm modes can be selected to suit your measurement applications.

MODE	Measurement Mode	Measurement Algorithm
A	Steady rotation measurement mode (Constant)	Maximum power spectrum peak detection method
B		Peak-interval mode method
C	Acceleration/deceleration rotation measurement mode (Active)	Maximum power spectrum peak detection method (Multi-order peak follow up method)
D		Maximum power spectrum peak detection method (Maximum power spectrum peak follow up method)
E		Maximum power spectrum peak detection method (Specific power spectrum peak follow up method)

- C, D, and E modes have improved high follow up performance via faster internal processing.
- Even when the maximum power spectrum peak is lost, the rotation speed is calculated by predicting the expected peak in C mode.
- D mode follows up the maximum power spectrum peak.
- E mode enables the selection of the appropriate rotation speed from up to eight frequency peaks.

### Maximum power spectrum peak detection method

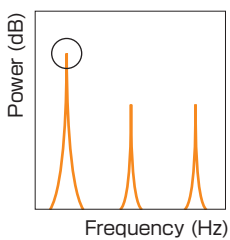

Calculates the frequency of the maximum peak in the power spectrum. Measurement is normally made in this mode.

### Peak-interval mode method

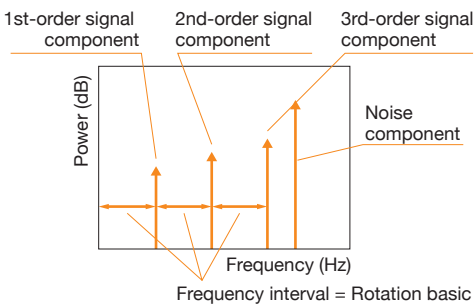

The FT-7200 continually calculates the frequency interval of each rotation order component. It determines the frequency interval that appeared the most as the 1st-order component of the rotation speed, and thereby decides the rotation speed. This method is effective when the 1st-order peak is unstable.

## Comparison of new algorithm (C Mode) of the FT-7200 with a previous model

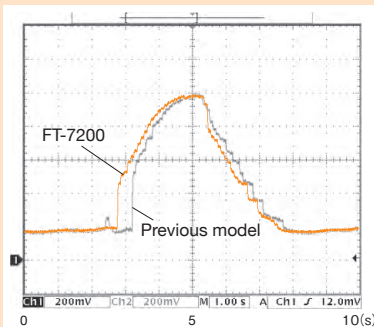
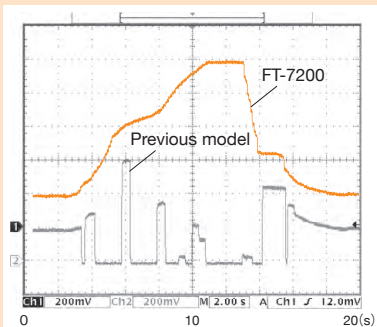

### Comparison of new Mode C of the FT-7200 with a previous model

Mode C can be used to measure rotating object that a previous model was unable to measure (see left). The FT-7200 also has improved follow up performance of rapid accelerated and decelerated rotation (see right).

(compared analog outputs by oscilloscope)



# Examples of Application

## ■ Rotation Speed Measurement of DC Motor

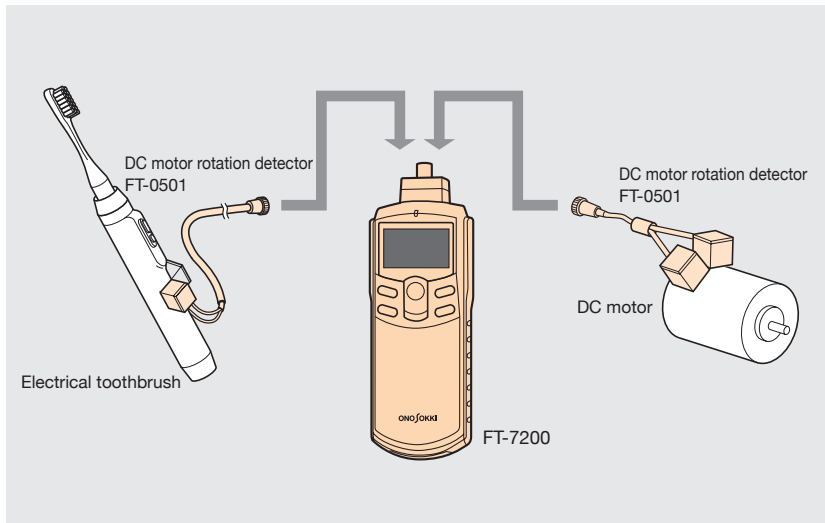

The FT-0501 detects the magnetic flux leakage of a DC motor, and calculates the frequency signal in proportion to rotation speed. This is able to measure the rotation speeds of built-in DC motors.

## ■ Rotation Speed Measurement of Finished Product

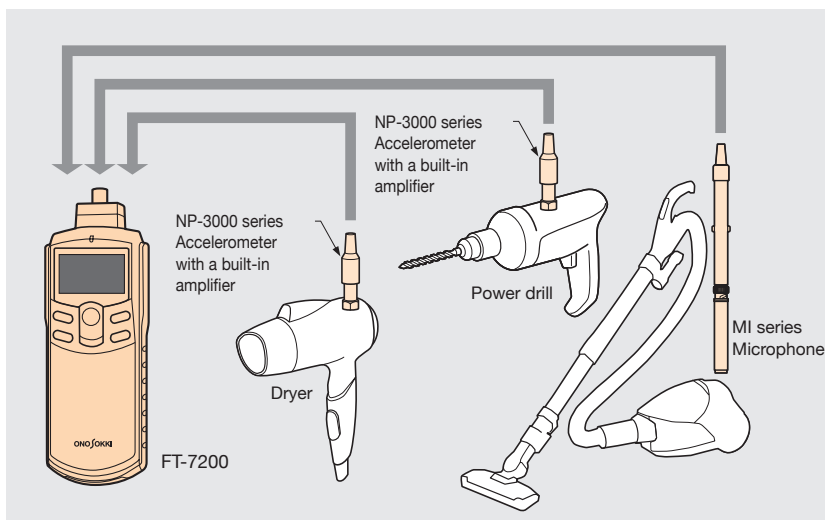

This product can measure the rotation speeds of motors in finished products where the motors are not visible, such as power drills and vacuum cleaners. Measurement is performed with a microphone, making it possible to perform measurement without modifying the measurement object.

## ■ Rotation Speed Measurement of Fans and Compressors

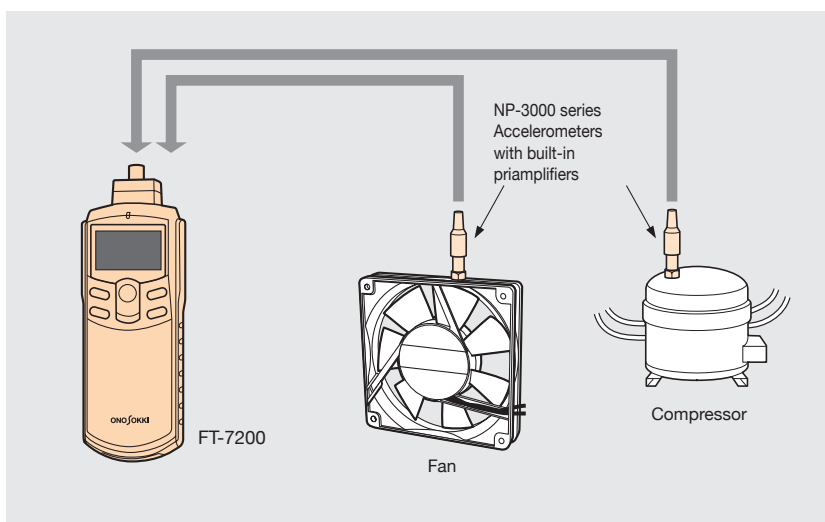

The vibration of a rotating object depends on the rotation movement. The rotation speed of a rotating object can be measured by measuring the vibration frequency.

( Some rotating objects and engines cannot be measured. Please check using the sensors and/or contact your nearest distributor. )

■ Rotation Speed Measurement of Automobile, Construction Machinery, and Other Engines

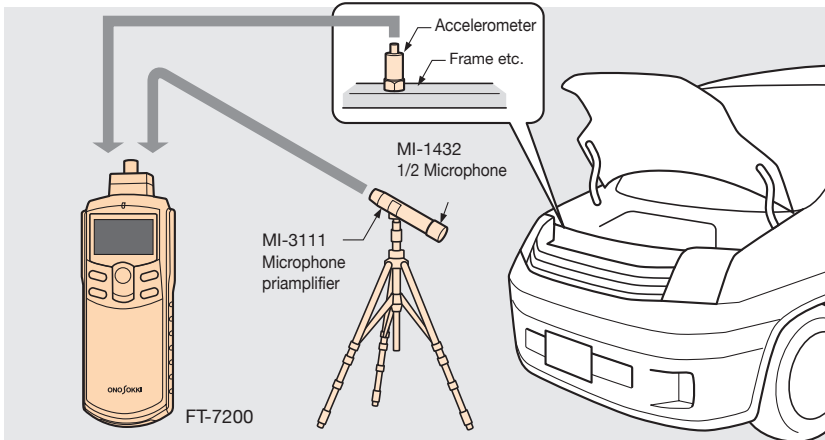

The rotation speed of engine can be measured from noise and vibration caused by the movement of pistons.

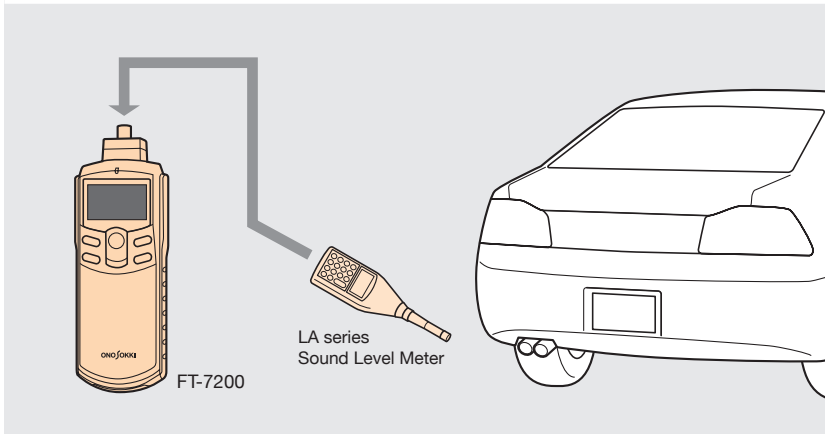

The rotation speed of engine can be measured from the noise of intake and exhaust from a muffler.

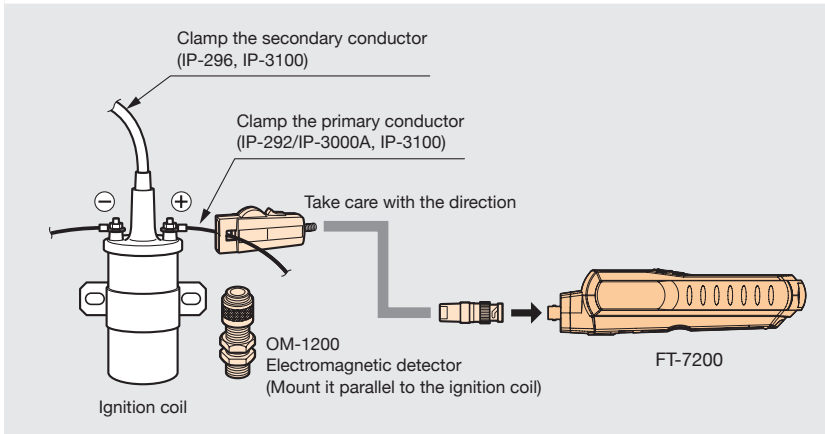

The rotation speed of engine can be measured by clamping sensors to an automobile's primary low-voltage and secondary high-voltage conductors.

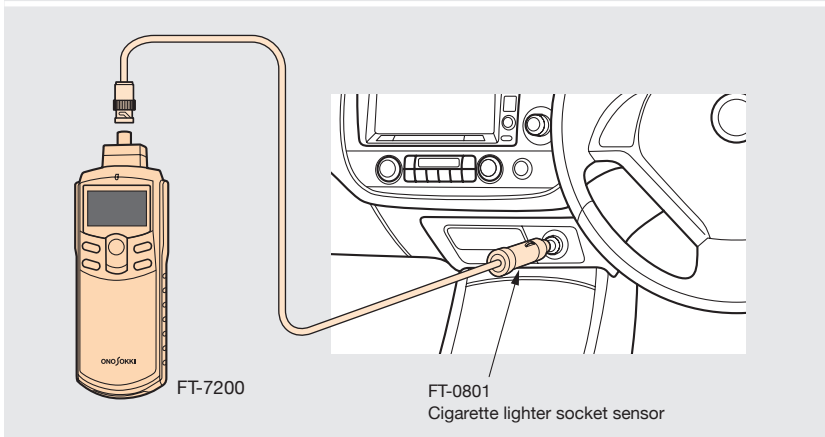

**Engine Measurement via the FT-0801 Cigarette Lighter Socket Sensor**

Connect the FT-0801 to a power outlet equipped on an automobile or construction machinery. It is possible to measure the rotation speed of engine using the FT-7200 by detecting the ignition noise in the voltage from the power outlet. Supports 12VDC and 24VDC batteries.

# System Configuration

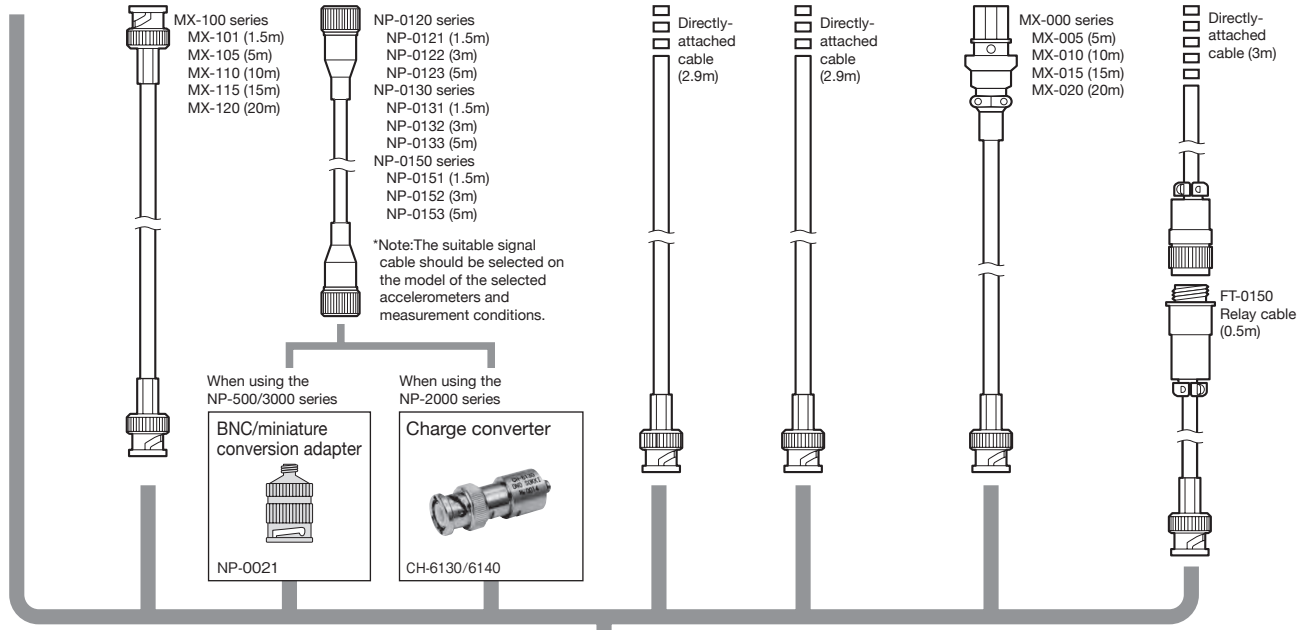
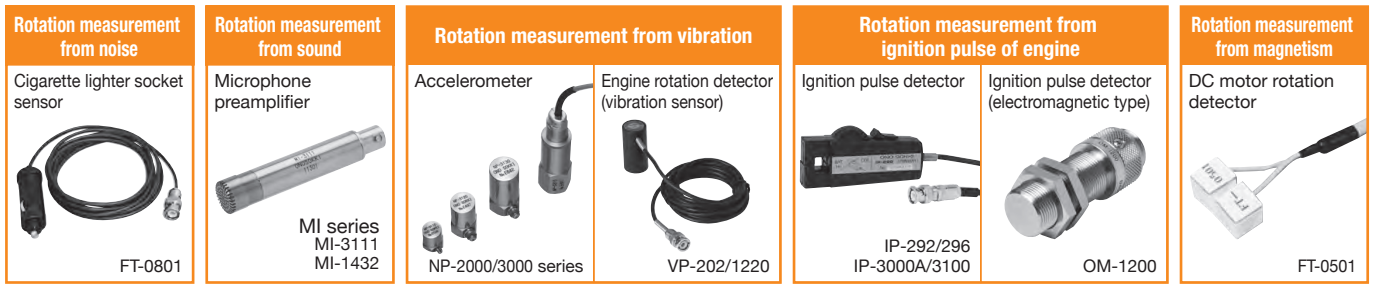

Note: MI series and NP series brochures are available separately.

Direct connection



## FT-7200 Advanced Handheld Tachometer

Note: All the peripheral equipments described on this page are sold separately as options.

Pulse output

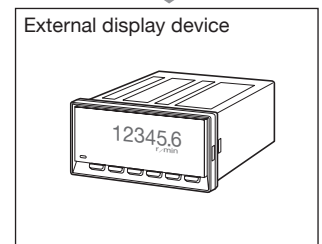
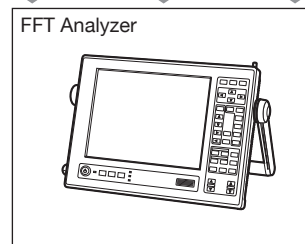
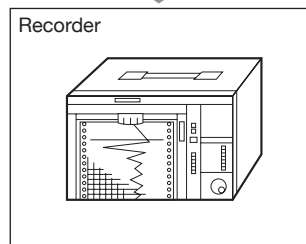
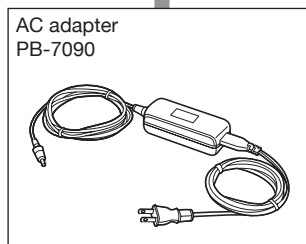

# FT-7200 Specification

## Measurement section

Measurement objects	DC motors, compressors, engines, and general rotating objects
Calculation method	FFT calculation
Measurement time	250ms or less
Input frequency range	2000Hz range: 30 to 2,000Hz (18,000 to 99,999r/min) *1 500Hz range: 7.5 to 500Hz (450 to 30,000r/min) *1 250Hz range: 3.75 to 250Hz (225 to 15,000r/min) *1 *1 r/min figures above are for 1P/R.
Measurement unit	r/min (rotation speed)
Rotation speed resolution	Frequency range (Hz) ÷ 6,400 x 60 ÷ the number of set pulses Frequency range: 250, 500, 2000 (Hz) Set pulse count: 0.5, 1, 1.5, etc. (P/R) 6400: FFT resolution Resolution drops when rotation speed is accelerating or decelerating.
Measurement accuracy	±2 x rotation speed resolution (r/min) ±1 Note: The measurement accuracy depends on the frequency range.
Filter function	Limits the target frequency range (rotation speed range) within the selected frequency ranges.
Averaging function	Moving average processing Number of averages: OFF, 2, 4, 8, 16
Sensor amplifier sensitivity adjustment dial	The sensor amplifier's sensitivity can be adjusted via the rotary dial on the right side of the main unit.

## Detection section

Applicable detectors	For engine rotation measurement	FT-0801, OM-1200, VP-1220, VP-202, IP-292, IP-296, IP-3000A, IP-3100 NP-3000 series (built-in preamplifier), MI-1432 + MI-3111 (microphone), magnetic flux leakage sensor
Input voltage level	5V: Max.±5V, 0.5V: Max.±0.5V, 0.05V: Max. ±0.05V	
Input coupling	AC coupling	
Power supply for the NP sensor	Constant current power supply (2.4 ±0.5mA)	

\* Note for measurement: Correct detection may not be possible depending on the type of engine or object under measurement.

## Display

Number of display digits	5
Character height	10.2mm
Display device	7-segment LCD with backlight
Display update time	0.5 ±0.2s
Display resolution	1r/min

## Measurement Mode

CNS (Constant)	Use when there is low fluctuation in the rotation speed of the measurement object. (when measuring rated rotation speed or similar)	Modes A, B
ACT (Active)	Use when the rotation speed of the measurement object accelerates and decelerates. (However, it may not be possible to measure correctly if the changes are sudden.)	Modes C, D, E

## Output section

[REVO] Analog output	
Signal output	Outputs the rotation speed displayed value
Voltage range	0 to 1 V / 0 to F.S (F.S. can be specified optionally.)
Conversion method	10-bit D/A conversion
Linearity	±1% of F.S.
Output update time	250ms or less
Temperature stability	±0.05% of F.S. /°C (ZERO & SPAN)
Setting error	±0.5% of F.S (Factory default of setting error; ZERO & SPAN)
Load resistance	100kΩ or more
Output connector	Ultra-mini jack (ø2.5)
[SIG] Analog output for monitor	
Signal output	Analog output for monitor after waveform shaping of the sensor signal
Load resistance	100 kΩ or more
Output connector	Ultra-mini jack (ø2.5 / common to REVO output)
[Output 2] Pulse output	
Signal output	Pulse output of power spectrum frequency extracted via FFT processing
Output voltage	Hi: 4.5V or more; Lo: 0.5V or less (when no load)
Output frequency range	3.75Hz to 2kHz Equivalent to displayed rotation speed x set number of pulses per rotation (P/R)
Load resistance	100 kΩ or more
Output connector	Ultra-mini jack
Output update time	250ms

## General Specification

Applicable standard	CE Marking
Power supply	Four type AAA batteries or exclusive AC adapter (PB-7090, sold separately)
Continuous operating time	Approx. 6 hours (with backlight OFF) Approx. 5 hours (with backlight ON) (Using alkaline batteries at 20°C; excludes when an NP sensor is in use*2) *2 Using an NP sensor increases the current consumption because of constant-current power drive. We therefore recommend using the exclusive AC adapter when an NP sensor is used.
Battery LOW display	The "LOW" mark lights up at approx. 4.2V.
Operating temperature range	0 to +40°C
Storage temperature range	-10 to +50°C
Operating humidity range	+35 to +85% RH (with no condensation)
Storage humidity range	+35 to +85% RH (with no condensation)
Weight	Approx. 230g (main unit only; not including batteries)
Outer dimensions	189.5(L) x 66.0(W) x 47.5 (D) mm (main unit only)
Accessories	Four type AAA alkaline batteries, three kinds of instruction manuals (one copy each), carrying case

# FT-0801 Specification

## Input section

Connector shape	Cigarette lighter socket
Input voltage	12/24 VDC (battery voltage)

## Output section

Connector shape	BNC
Filter	High-pass filter

\* The FT-0801 performs AC coupling processing, protecting the FT-7200 from overvoltage.

## General Specification

Cable length	2m
Operating temperature range	0 to +40°C
Storage temperature range	-10 to +50°C
Weight	Approx. 75g
Outer dimensions	ø22.3 x 69mm

## Applicable sensors and options (sold separately)

<p>Cigarette lighter socket sensor FT-0801</p> 	<p>Ignition pulse detector (primary side) IP-292</p> 	<p>Ignition pulse detector (secondary side) IP-296</p> 	<p><b>Main unit</b></p> <ul style="list-style-type: none"> <li>● FT-7200      Advanced Handheld Tachometer</li> </ul> <hr/> <p><b>Detectors</b></p> <ul style="list-style-type: none"> <li>● FT-0801      Cigarette lighter socket sensor</li> <li>● IP-292        Ignition pulse detector (primary side)</li> <li>● IP-296        Ignition pulse detector (secondary side)</li> <li>● IP-3000A     Ignition pulse detector</li> <li>● IP-3100       Ignition pulse detector</li> <li>● OM-1200     Ignition pulse detector (electromagnetic type)</li> <li>● FT-0501     DC motor rotation detector</li> <li>● VP-202       Engine rotation detector</li> <li>● VP-1220     Engine rotation detector (high-sensitive type)</li> <li>● NP-2000     Accelerometer /NP-3000 series</li> <li>● MI series     Microphone + preamplifier</li> </ul> <hr/> <p><b>Accessories</b></p> <ul style="list-style-type: none"> <li>● HT-0522     Magnetic stand</li> <li>● HT-0521A    Stand jig</li> <li>● LA-0203C*1   Tripod for sound level meter</li> <li>● PB-7090*2   AC adapter (input :100 to 240VAC) (output :5.9VDC/3.5A)</li> <li>● AX-501       Signal cable (2m) (Can be used for analog and pulse outputs.) ø2.5 pin plug – CO2 (BNC)</li> </ul> <p>*1: Made by Slik Corporation (splint PRO II GM) *2: Made by Adapter Technology</p>
<p>Ignition pulse detector IP-3000A</p> 	<p>Ignition pulse detector IP-3100</p> 	<p>Ignition pulse detector (electromagnetic type) OM-1200</p> 	
<p>DC motor rotation detector FT-0501</p> 	<p>Engine rotation detector VP-202</p> 	<p>Engine rotation detector (high-sensitive type) VP-1220</p> 	
<p>Accelerometer NP-2000/3000 series</p> 	<p>Microphone + preamplifier MI series</p> 	<p>Magnetic stand / stand jig HT-0522/0521A</p> 	
<p>Tripod for sound level meter LA-0203C*1</p> 	<p>Signal cable AX-501</p> 		

## Outer Dimensions

Unit (mm)

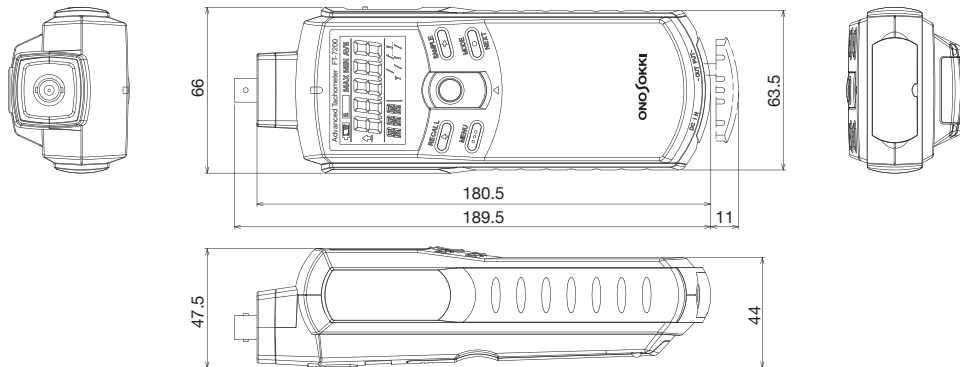

• Microsoft® and Windows® are registered trademarks of Microsoft Corporation in the United States and other countries. All other company names and product names used in this brochure are the product names or registered trademarks of their respective holders.

**ONOSOKKI**

• Outer appearance and specifications are subject to change without prior notice.  
URL: <http://www.onosokki.co.jp/English/english.htm>

**U.S.A**  
Ono Sokki Technology Inc.  
2171 Executive Drive, Suite 400  
Addison, IL. 60101, U.S.A  
Phone : +1-630-627-9700  
Fax : +1-630-627-0004  
E-mail : info@onosokki.net  
<http://www.onosokki.net>

**THAILAND**  
Ono Sokki (Thailand) Co., Ltd.  
29/67 Moo 5 Tivanon Road, Pakkred,  
Nonthaburi 11120, Thailand  
Phone : +66-2-964-3884  
Fax : +66-2-964-3887  
E-mail : osth\_sales@onosokki.co.jp

**P.R.CHINA**  
Ono Sokki Beijing Office  
Beijing Jing Guang Center 3510  
Hu Jia Lou, Chao Yang Qu  
Beijing 100020, P.R.China  
Phone : +86-10-6597-3113  
Fax : +86-10-6597-3114  
E-mail : onosokki@bbn.cn

**WORLDWIDE**  
Ono Sokki Co., Ltd.  
3-9-3 Shin-Yokohama, Kohoku-ku,  
Yokohama 222-8507, Japan  
Phone : +81-45-476-9712  
Fax : +81-45-470-7244  
E-mail : overseas@onosokki.co.jp